

TECHNICAL SPECIFICATION

COLOURS

BODY, FRONT, COUNTER TOP



31 CANADIAN OAK

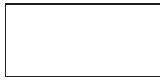

67 WHITE PASTEL



106 LOWLAND NUT

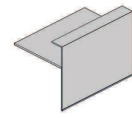
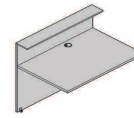

HPL ELEMENTS STRUCTURE



31 CANADIAN OAK



67 WHITE PASTEL



106 LOWLAND NUT

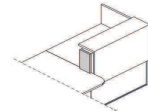
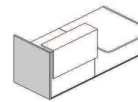

CORNER UNIT



73 HIGH GLOSS WHITE



101 HIGH GLOSS BLACK



155 ANTHRACITE HIGH GLOSS

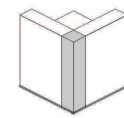

OPTIONAL TOP ELEMENT WITH LIGHT



73 HIGH GLOSS WHITE

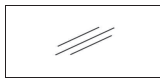

WHITE, LACOBEL

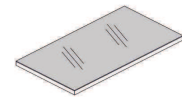
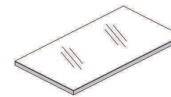

101 HIGH GLOSS BLACK



BLACK, LACOBEL

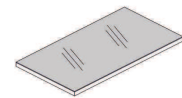
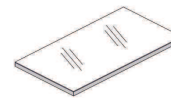

155 ANTHRACITE HIGH GLOSS



ANTHRACITE, LACOBEL

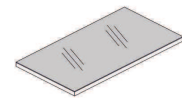
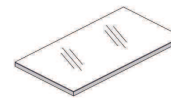

SUPPORTING LEG WHERE WORKTOPS CONNECT NL41



15 HIGH GLOSS WHITE

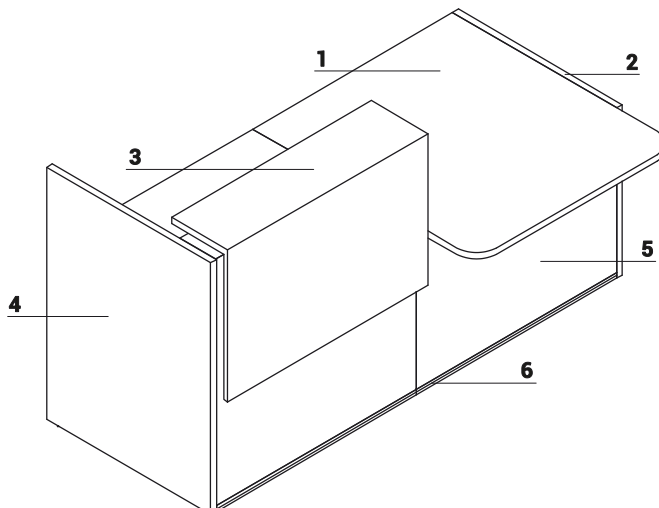

1. **Worktop** - MFC 28mm, PVC edge
2. **Low side panel** - MFC 28mm, PVC edge
3. **Optional top element with lightening** - top melamine board 28mm + Glass LACOBEL 4mm, front melamine board 18mm, all in HPL - gloss
4. **High side panel** - MFC 28mm, PVC edge
5. **Front** - MFC 18mm, PVC edge
6. **Decorative stripe** - PVC, colour 09-aluminum